

**150mA RF ULDO REGULATOR****AP2202****General Description**

The AP2202 is a 150mA ULDO regulator which provides very low noise, ultra low dropout voltage (typically 165mV at 150mA), very low standby current (1 μ A maximum) and excellent power supply ripple rejection (PSRR 75dB at 100Hz) in battery powered applications, such as handsets and PDAs and in noise sensitive applications, such as RF electronics.

The AP2202 also features logic compatible enable/shutdown control inputs, a low power shutdown mode for extended battery life, over current protection, over temperature protection, as well as reversed-battery protection.

The AP2202 has adjustable, 2.5V, 2.6V, 2.7V, 2.8V, 2.9V, 3.0V, 3.3V and 4.0V versions.

The AP2202 is available in space saving SOT-23-5 and SOT-89-3 packages.

Features

- Up to 150mA Output Current
- Low Standby Current
- Low Dropout Voltage: $V_{DROPO} = 165\text{mV}$ at 150mA
- High Output Accuracy: $\pm 1\%$
- Good Ripple Rejection Ability: 75dB at 100Hz and $I_{OUT} = 100\mu\text{A}$
- Tight Load and Line Regulation
- Low Temperature Coefficient
- Over Current Protection
- Thermal Protection
- Reverse-battery Protection
- Logic-controlled Enable

Applications

- Cellular Phones
- Cordless Phones
- Digital Still Cameras
- Wireless Communicators
- PDAs / Palmtops
- PC Mother Board
- Consumer Electronics

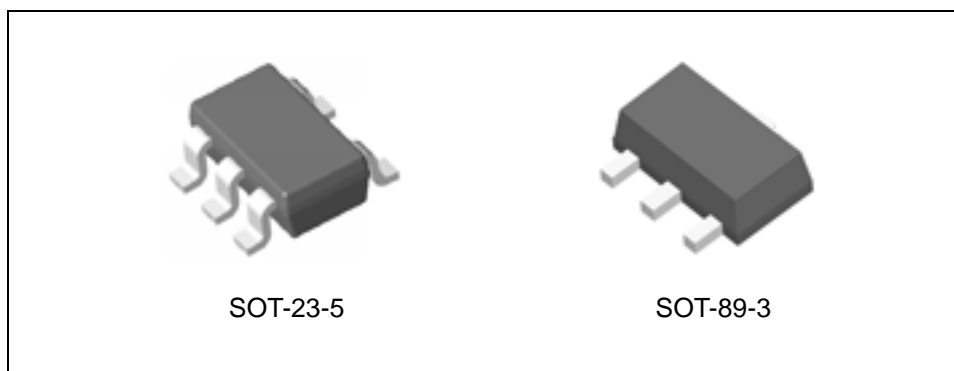

Figure 1. Package Types of AP2202



150mA RF ULDO REGULATOR

AP2202

Pin Configuration

K Package
(SOT-23-5)

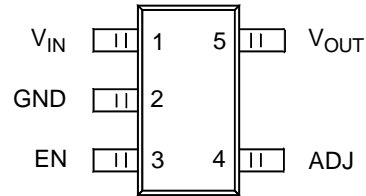
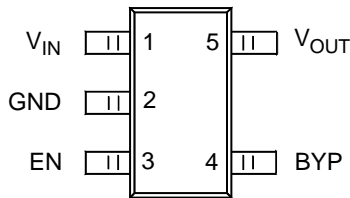

R Package
(SOT-89-3)

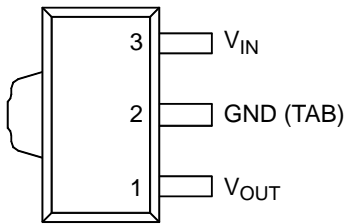

Figure 2. Pin Configuration of AP2202 (Top View)

Pin Description

Pin Number		Pin Name	Function
SOT-23-5	SOT-89-3		
1	3	V _{IN}	Input voltage
2	2	GND	Ground (TAB for SOT-89-3)
3		EN	Enable input: CMOS or TTL compatible input. Logic high=enable, logic low=shutdown
4		BYP/ADJ	Bypass capacitor for low noise operation/Adjust output
5	1	V _{OUT}	Regulated output voltage



150mA RF ULDO REGULATOR

AP2202

Functional Block Diagram

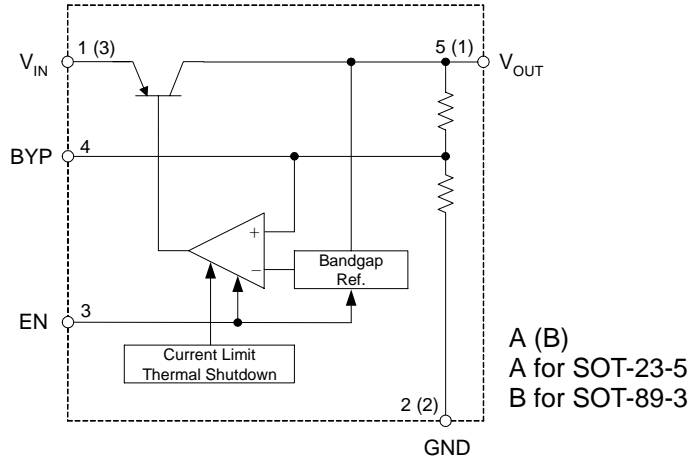

A (B)
A for SOT-23-5
B for SOT-89-3

Fixed Regulator

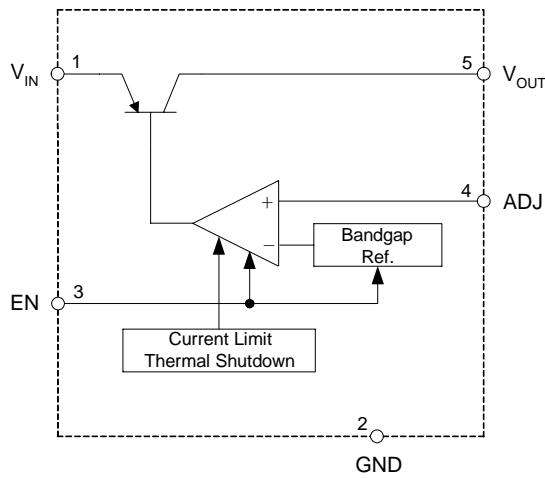

Adjustable Regulator

Figure 3. Functional Block Diagram of AP2202



150mA RF ULDO REGULATOR

AP2202

Ordering Information

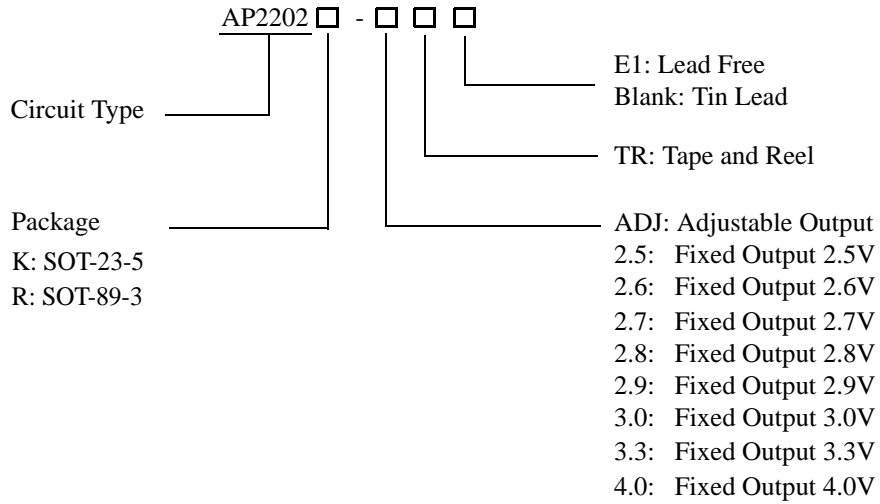

Package	Temperature Range	Part Number		Marking ID		Packing Type
		Tin Lead	Lead Free	Tin Lead	Lead Free	
SOT-23-5	-40 to 125°C	AP2202K-ADJTR	AP2202K-ADJTRE1	K2C	E2C	Tape & Reel
		AP2202K-2.5TR	AP2202K-2.5TRE1	K2D	E2D	Tape & Reel
		AP2202K-2.6TR	AP2202K-2.6TRE1	K2E	E2E	Tape & Reel
		AP2202K-2.7TR	AP2202K-2.7TRE1	K2F	E2F	Tape & Reel
		AP2202K-2.8TR	AP2202K-2.8TRE1	K2G	E2G	Tape & Reel
		AP2202K-2.9TR	AP2202K-2.9TRE1	K2H	E2H	Tape & Reel
		AP2202K-3.0TR	AP2202K-3.0TRE1	K2I	E2I	Tape & Reel
		AP2202K-3.3TR	AP2202K-3.3TRE1	K2L	E2L	Tape & Reel
SOT-89-3	-40 to 125°C	AP2202R-3.3TR	AP2202R-3.3TRE1	R22B	E22B	Tape & Reel

BCD Semiconductor's Pb-free products, as designated with "E1" suffix in the part number, are RoHS compliant.

**150mA RF ULDO REGULATOR****AP2202****Absolute Maximum Ratings (Note 1)**

Parameter	Symbol	Value		Unit
Supply Input Voltage	V_{IN}	15		V
Enable Input Voltage	V_{EN}	15		V
Power Dissipation	P_D	Internally Limited (Thermal Protection)		W
Lead Temperature (Soldering, 10sec)	T_{LEAD}	260		°C
Junction Temperature	T_J	150		°C
Storage Temperature	T_{STG}	-65 to 150		°C
ESD (Machine Model)		200		V
Thermal Resistance (No Heatsink)	θ_{JA}	SOT-23-5	200	°C/W
		SOT-89-3	165	

Note 1: Stresses greater than those listed under "Absolute Maximum Ratings" may cause permanent damage to the device. These are stress ratings only, and functional operation of the device at these or any other conditions beyond those indicated under "Recommended Operating Conditions" is not implied. Exposure to "Absolute Maximum Ratings" for extended periods may affect device reliability.

Recommended Operating Conditions

Parameter	Symbol	Min	Max	Unit
Supply Input Voltage	V_{IN}	2.5	13.2	V
Enable Input Voltage	V_{EN}	0	13.2	V
Operating Junction Temperature	T_J	-40	125	°C



150mA RF ULDO REGULATOR

AP2202

Electrical Characteristics

AP2202-ADJ Electrical Characteristics

$V_{IN}=V_{OUT}+1V$, $I_{OUT}=100\mu A$, $C_{IN}=1.0\mu F$, $C_{OUT}=2.2\mu F$, $V_{EN}\geq 2.0V$, $T_J=25^\circ C$, **Bold** typeface applies over $-40^\circ C\leq T_J\leq 125^\circ C$ (note 2), unless otherwise specified.

Parameter	Symbol	Conditions	Min	Typ	Max	Unit
Output Voltage Accuracy	$\Delta V_{OUT}/V_{OUT}$	Variation from specified V_{OUT}	-1		1	%
			-2		2	
Output Voltage Temperature Coefficient (Note 3)	$\Delta V_{OUT}/\Delta T$			120		$\mu V/^\circ C$
Line Regulation	V_{RLINE}	$V_{IN}=V_{OUT}+1V$ to 13.2V		0.004	0.012	%/V
					0.05	
Load Regulation (Note 4)	V_{RLOAD}	$I_{OUT}=0.1mA$ to 150mA		0.02	0.2	%
					0.5	
Dropout Voltage (Note 5)	V_{DROP}	$I_{OUT}=100\mu A$		15	50	mV
		$I_{OUT}=50mA$		110	150	
					230	
		$I_{OUT}=100mA$		140	250	
$I_{OUT}=150mA$		165	275			
			350			
Standby Current	I_{STD}	$V_{EN}\leq 0.4V$ (shutdown)		0.01	1	μA
		$V_{EN}\leq 0.18V$ (shutdown)			5	
Ground Pin Current (Note 6)	I_{GND}	$V_{EN}\geq 2.0V$, $I_{OUT}=0\mu A$		95	130	μA
		$V_{EN}\geq 2.0V$, $I_{OUT}=100\mu A$		98	140	
					160	
		$V_{EN}\geq 2.0V$, $I_{OUT}=50mA$		350	600	
		$V_{EN}\geq 2.0V$, $I_{OUT}=100mA$		600	1000	
			1500			
$V_{EN}\geq 2.0V$, $I_{OUT}=150mA$		1300	1900			
			2500			
Ripple Rejection	PSRR	frequency=100Hz, $I_{OUT}=100\mu A$		75		dB
Current Limit	I_{LIMIT}	$V_{OUT}=0V$		320	550	mA
Output Noise	e_{no}	$I_{OUT}=50mA$, $C_{OUT}=2.2\mu F$, 100pF from BYP to GND		260		nV/\sqrt{Hz}
Enable Input Logic-Low Voltage	V_{IL}	Regulator shutdown			0.4	V
					0.18	

**150mA RF ULDO REGULATOR****AP2202****Electrical Characteristics (Continued)****AP2202-ADJ Electrical Characteristics**

$V_{IN}=V_{OUT}+1V$, $I_{OUT}=100\mu A$, $C_{IN}=1.0\mu F$, $C_{OUT}=2.2\mu F$, $V_{EN}\geq 2.0V$, $T_J=25^\circ C$, **Bold** typeface applies over $-40^\circ C\leq T_J\leq 125^\circ C$ (note 2), unless otherwise specified.

Parameter	Symbol	Conditions	Min	Typ	Max	Unit
Enable Input Logic-High Voltage	V_{IH}	Regulator enabled	2.0			V
Enable Input Logic-Low Current	I_{IL}	$V_{IL}\leq 0.4V$		0.01	1	μA
		$V_{IL}\leq 0.18V$			2	
Enable Input Logic-High Current	I_{IH}	$V_{IH}\geq 2.0V$		5	20	μA
		$V_{IH}\geq 2.0V$			25	

Note 2: Specifications in bold type are limited to $-40^\circ C\leq T_J\leq 125^\circ C$. Limits over temperature are guaranteed by design, but not tested in production.

Note 3: Output voltage temperature coefficient is defined as the worst case voltage change divided by the total temperature range.

Note 4: Regulation is measured at constant junction temperature using low duty cycle pulse testing. Parts are tested for load regulation in the load range from 0.1mA to 150mA. Changes in output voltage due to heating effects are covered by the thermal regulation specification.

Note 5: Dropout voltage is defined as the input to output differential at which the output voltage drops 1% ($T_J=25^\circ C$) or 2% ($-40^\circ C\leq T_J\leq 125^\circ C$) below its nominal value measured at 1V differential.

Note 6: Ground pin current is the regulator quiescent current plus pass transistor base current. The total current drawn from the supply is the sum of the load current plus the ground pin current.



150mA RF ULDO REGULATOR

AP2202

Electrical Characteristics (Continued)

AP2202-2.5 Electrical Characteristics

$V_{IN}=3.5V$, $I_{OUT}=100\mu A$, $C_{IN}=1.0\mu F$, $C_{OUT}=2.2\mu F$, $V_{EN}\geq 2.0V$, $T_J=25^\circ C$, **Bold** typeface applies over $-40^\circ C\leq T_J\leq 125^\circ C$ (note 2), unless otherwise specified.

Parameter	Symbol	Conditions	Min	Typ	Max	Unit
Output Voltage Accuracy	$\Delta V_{OUT}/V_{OUT}$	Variation from specified V_{OUT}	-1		1	%
			-2		2	
Output Voltage Temperature Coefficient (Note 3)	$\Delta V_{OUT}/\Delta T$			120		$\mu V/^\circ C$
	$(\Delta V_{OUT}/V_{OUT})/\Delta T$			48		ppm/ $^\circ C$
Line Regulation	V_{RLINE}	$V_{IN}=3.5V$ to $13.2V$		1	3	mV
					13	
Load Regulation (Note 4)	V_{RLOAD}	$I_{OUT}=0.1mA$ to $150mA$		1	5	mV
					13	
Dropout Voltage (Note 5)	V_{DROP}	$I_{OUT}=100\mu A$		15	50	mV
				70		
		$I_{OUT}=50mA$		110	150	
				230		
		$I_{OUT}=100mA$		140	250	
				300		
		$I_{OUT}=150mA$		165	275	
				350		
Standby Current	I_{STD}	$V_{EN}\leq 0.4V$ (shutdown)		0.01	1	μA
		$V_{EN}\leq 0.18V$ (shutdown)			5	
Ground Pin Current (Note 6)	I_{GND}	$V_{EN}\geq 2.0V$, $I_{OUT}=0\mu A$		95	130	μA
				150		
		$V_{EN}\geq 2.0V$, $I_{OUT}=100\mu A$		98	140	
				160		
		$V_{EN}\geq 2.0V$, $I_{OUT}=50mA$		350	600	
		800				
		$V_{EN}\geq 2.0V$, $I_{OUT}=100mA$		600	1000	
				1500		
		$V_{EN}\geq 2.0V$, $I_{OUT}=150mA$		1300	1900	
				2500		
Ripple Rejection	PSRR	frequency=100Hz, $I_{OUT}=100\mu A$		75		dB
Current Limit	I_{LIMIT}	$V_{OUT}=0V$		320	550	mA
Output Noise	e_{no}	$I_{OUT}=50mA$, $C_{OUT}=2.2\mu F$, 100pF from BYP to GND		260		nV/\sqrt{Hz}
Enable Input Logic-Low Voltage	V_{IL}	Regulator shutdown			0.4	V
					0.18	

**150mA RF ULDO REGULATOR****AP2202****Electrical Characteristics (Continued)****AP2202-2.5 Electrical Characteristics**

$V_{IN}=3.5V$, $I_{OUT}=100\mu A$, $C_{IN}=1.0\mu F$, $C_{OUT}=2.2\mu F$, $V_{EN}\geq 2.0V$, $T_J=25^\circ C$, **Bold** typeface applies over $-40^\circ C\leq T_J\leq 125^\circ C$ (note 2), unless otherwise specified.

Parameter	Symbol	Conditions	Min	Typ	Max	Unit
Enable Input Logic-High Voltage	V_{IH}	Regulator enabled	2.0			V
Enable Input Logic-Low Current	I_{IL}	$V_{IL}\leq 0.4V$		0.01	1	μA
		$V_{IL}\leq 0.18V$			2	
Enable Input Logic-High Current	I_{IH}	$V_{IH}\geq 2.0V$		5	20	μA
		$V_{IH}\geq 2.0V$			25	

Note 2: Specifications in bold type are limited to $-40^\circ C\leq T_J\leq 125^\circ C$. Limits over temperature are guaranteed by design, but not tested in production.

Note 3: Output voltage temperature coefficient is defined as the worst case voltage change divided by the total temperature range.

Note 4: Regulation is measured at constant junction temperature using low duty cycle pulse testing. Parts are tested for load regulation in the load range from 0.1mA to 150mA. Changes in output voltage due to heating effects are covered by the thermal regulation specification.

Note 5: Dropout voltage is defined as the input to output differential at which the output voltage drops 1% ($T_J=25^\circ C$) or 2% ($-40^\circ C\leq T_J\leq 125^\circ C$) below its nominal value measured at 1V differential.

Note 6: Ground pin current is the regulator quiescent current plus pass transistor base current. The total current drawn from the supply is the sum of the load current plus the ground pin current.



150mA RF ULDO REGULATOR

AP2202

Electrical Characteristics (Continued)

AP2202-2.6 Electrical Characteristics

$V_{IN}=3.6V$, $I_{OUT}=100\mu A$, $C_{IN}=1.0\mu F$, $C_{OUT}=2.2\mu F$, $V_{EN}\geq 2.0V$, $T_J=25^\circ C$, **Bold** typeface applies over $-40^\circ C \leq T_J \leq 125^\circ C$ (note 2), unless otherwise specified.

Parameter	Symbol	Conditions	Min	Typ	Max	Unit
Output Voltage Accuracy	$\Delta V_{OUT}/V_{OUT}$	Variation from specified V_{OUT}	-1		1	%
			-2		2	
Output Voltage Temperature Coefficient (Note 3)	$\Delta V_{OUT}/\Delta T$			120		$\mu V/^\circ C$
	$(\Delta V_{OUT}/V_{OUT})/\Delta T$			46		ppm/ $^\circ C$
Line Regulation	V_{RLINE}	$V_{IN}=3.6V$ to $13.2V$		1	3	mV
					13	
Load Regulation (Note 4)	V_{RLOAD}	$I_{OUT}=0.1mA$ to $150mA$		1	6	mV
					14	
Dropout Voltage (Note 5)	V_{DROP}	$I_{OUT}=100\mu A$		15	50	mV
				70		
		$I_{OUT}=50mA$		110	150	
				230		
		$I_{OUT}=100mA$		140	250	
					300	
		$I_{OUT}=150mA$		165	275	
					350	
Standby Current	I_{STD}	$V_{EN}\leq 0.4V$ (shutdown)		0.01	1	μA
		$V_{EN}\leq 0.18V$ (shutdown)			5	
Ground Pin Current (Note 6)	I_{GND}	$V_{EN}\geq 2.0V$, $I_{OUT}=0\mu A$		95	130	μA
					150	
		$V_{EN}\geq 2.0V$, $I_{OUT}=100\mu A$		98	140	
					160	
		$V_{EN}\geq 2.0V$, $I_{OUT}=50mA$		350	600	
			800			
		$V_{EN}\geq 2.0V$, $I_{OUT}=100mA$		600	1000	
					1500	
		$V_{EN}\geq 2.0V$, $I_{OUT}=150mA$		1300	1900	
					2500	
Ripple Rejection	PSRR	frequency=100Hz, $I_{OUT}=100\mu A$		75		dB
Current Limit	I_{LIMIT}	$V_{OUT}=0V$		320	550	mA
Output Noise	e_{no}	$I_{OUT}=50mA$, $C_{OUT}=2.2\mu F$, 100pF from BYP to GND		260		nV/\sqrt{Hz}
Enable Input Logic-Low Voltage	V_{IL}	Regulator shutdown			0.4	V
					0.18	

**150mA RF ULDO REGULATOR****AP2202****Electrical Characteristics (Continued)****AP2202-2.6 Electrical Characteristics**

$V_{IN}=3.6V$, $I_{OUT}=100\mu A$, $C_{IN}=1.0\mu F$, $C_{OUT}=2.2\mu F$, $V_{EN}\geq 2.0V$, $T_J=25^\circ C$, **Bold** typeface applies over $-40^\circ C\leq T_J\leq 125^\circ C$ (note 2), unless otherwise specified.

Parameter	Symbol	Conditions	Min	Typ	Max	Unit
Enable Input Logic-High Voltage	V_{IH}	Regulator enabled	2.0			V
Enable Input Logic-Low Current	I_{IL}	$V_{IL}\leq 0.4V$		0.01	1	μA
		$V_{IL}\leq 0.18V$			2	
Enable Input Logic-High Current	I_{IH}	$V_{IH}\geq 2.0V$		5	20	μA
		$V_{IH}\geq 2.0V$			25	

Note 2: Specifications in bold type are limited to $-40^\circ C\leq T_J\leq 125^\circ C$. Limits over temperature are guaranteed by design, but not tested in production.

Note 3: Output voltage temperature coefficient is defined as the worst case voltage change divided by the total temperature range.

Note 4: Regulation is measured at constant junction temperature using low duty cycle pulse testing. Parts are tested for load regulation in the load range from 0.1mA to 150mA. Changes in output voltage due to heating effects are covered by the thermal regulation specification.

Note 5: Dropout voltage is defined as the input to output differential at which the output voltage drops 1% ($T_J=25^\circ C$) or 2% ($-40^\circ C\leq T_J\leq 125^\circ C$) below its nominal value measured at 1V differential.

Note 6: Ground pin current is the regulator quiescent current plus pass transistor base current. The total current drawn from the supply is the sum of the load current plus the ground pin current.



150mA RF ULDO REGULATOR

AP2202

Electrical Characteristics (Continued)

AP2202-2.7 Electrical Characteristics

$V_{IN}=3.7V$, $I_{OUT}=100\mu A$, $C_{IN}=1.0\mu F$, $C_{OUT}=2.2\mu F$, $V_{EN}\geq 2.0V$, $T_J=25^\circ C$, **Bold** typeface applies over $-40^\circ C \leq T_J \leq 125^\circ C$ (note 2), unless otherwise specified.

Parameter	Symbol	Conditions	Min	Typ	Max	Unit
Output Voltage Accuracy	$\Delta V_{OUT}/V_{OUT}$	Variation from specified V_{OUT}	-1		1	%
			-2		2	
Output Voltage Temperature Coefficient (Note 3)	$\Delta V_{OUT}/\Delta T$			120		$\mu V/^\circ C$
	$(\Delta V_{OUT}/V_{OUT})/\Delta T$			44.4		ppm/ $^\circ C$
Line Regulation	V_{RLINE}	$V_{IN}=3.7V$ to $13.2V$		1	4	mV
					14	
Load Regulation (Note 4)	V_{RLOAD}	$I_{OUT}=0.1mA$ to $150mA$		1	6	mV
					14	
Dropout Voltage (Note 5)	V_{DROP}	$I_{OUT}=100\mu A$		15	50	mV
				70		
		$I_{OUT}=50mA$		110	150	
				230		
		$I_{OUT}=100mA$		140	250	
					300	
		$I_{OUT}=150mA$		165	275	
					350	
Standby Current	I_{STD}	$V_{EN}\leq 0.4V$ (shutdown)		0.01	1	μA
		$V_{EN}\leq 0.18V$ (shutdown)			5	
Ground Pin Current (Note 6)	I_{GND}	$V_{EN}\geq 2.0V$, $I_{OUT}=0\mu A$		95	130	μA
					150	
		$V_{EN}\geq 2.0V$, $I_{OUT}=100\mu A$		98	140	
					160	
		$V_{EN}\geq 2.0V$, $I_{OUT}=50mA$		350	600	
			800			
		$V_{EN}\geq 2.0V$, $I_{OUT}=100mA$		600	1000	
					1500	
		$V_{EN}\geq 2.0V$, $I_{OUT}=150mA$		1300	1900	
					2500	
Ripple Rejection	PSRR	frequency=100Hz, $I_{OUT}=100\mu A$		75		dB
Current Limit	I_{LIMIT}	$V_{OUT}=0V$		320	550	mA
Output Noise	e_{no}	$I_{OUT}=50mA$, $C_{OUT}=2.2\mu F$, 100pF from BYP to GND		260		nV/\sqrt{Hz}
Enable Input Logic-Low Voltage	V_{IL}	Regulator shutdown			0.4	V
					0.18	

**150mA RF ULDO REGULATOR****AP2202****Electrical Characteristics (Continued)****AP2202-2.7 Electrical Characteristics**

$V_{IN}=3.7V$, $I_{OUT}=100\mu A$, $C_{IN}=1.0\mu F$, $C_{OUT}=2.2\mu F$, $V_{EN}\geq 2.0V$, $T_J=25^\circ C$, **Bold** typeface applies over $-40^\circ C\leq T_J\leq 125^\circ C$ (note 2), unless otherwise specified.

Parameter	Symbol	Conditions	Min	Typ	Max	Unit
Enable Input Logic-High Voltage	V_{IH}	Regulator enabled	2.0			V
Enable Input Logic-Low Current	I_{IL}	$V_{IL}\leq 0.4V$		0.01	1	μA
		$V_{IL}\leq 0.18V$			2	
Enable Input Logic-High Current	I_{IH}	$V_{IH}\geq 2.0V$		5	20	μA
		$V_{IH}\geq 2.0V$			25	

Note 2: Specifications in bold type are limited to $-40^\circ C\leq T_J\leq 125^\circ C$. Limits over temperature are guaranteed by design, but not tested in production.

Note 3: Output voltage temperature coefficient is defined as the worst case voltage change divided by the total temperature range.

Note 4: Regulation is measured at constant junction temperature using low duty cycle pulse testing. Parts are tested for load regulation in the load range from 0.1mA to 150mA. Changes in output voltage due to heating effects are covered by the thermal regulation specification.

Note 5: Dropout voltage is defined as the input to output differential at which the output voltage drops 1% ($T_J=25^\circ C$) or 2% ($-40^\circ C\leq T_J\leq 125^\circ C$) below its nominal value measured at 1V differential.

Note 6: Ground pin current is the regulator quiescent current plus pass transistor base current. The total current drawn from the supply is the sum of the load current plus the ground pin current.



150mA RF ULDO REGULATOR

AP2202

Electrical Characteristics (Continued)

AP2202-2.8 Electrical Characteristics

$V_{IN}=3.8V$, $I_{OUT}=100\mu A$, $C_{IN}=1.0\mu F$, $C_{OUT}=2.2\mu F$, $V_{EN}\geq 2.0V$, $T_J=25^\circ C$, **Bold** typeface applies over $-40^\circ C \leq T_J \leq 125^\circ C$ (note 2), unless otherwise specified.

Parameter	Symbol	Conditions	Min	Typ	Max	Unit
Output Voltage Accuracy	$\Delta V_{OUT}/V_{OUT}$	Variation from specified V_{OUT}	-1		1	%
			-2		2	
Output Voltage Temperature Coefficient (Note 3)	$\Delta V_{OUT}/\Delta T$			120		$\mu V/^\circ C$
	$(\Delta V_{OUT}/V_{OUT})/\Delta T$			42.8		ppm/ $^\circ C$
Line Regulation	V_{RLINE}	$V_{IN}=3.8V$ to $13.2V$		1	4	mV
					14	
Load Regulation (Note 4)	V_{RLOAD}	$I_{OUT}=0.1mA$ to $150mA$		1	6	mV
					14	
Dropout Voltage (Note 5)	V_{DROP}	$I_{OUT}=100\mu A$		15	50	mV
				70		
		$I_{OUT}=50mA$		110	150	
				230		
		$I_{OUT}=100mA$		140	250	
				300		
		$I_{OUT}=150mA$		165	275	
				350		
Standby Current	I_{STD}	$V_{EN}\leq 0.4V$ (shutdown)		0.01	1	μA
		$V_{EN}\leq 0.18V$ (shutdown)			5	
Ground Pin Current (Note 6)	I_{GND}	$V_{EN}\geq 2.0V$, $I_{OUT}=0\mu A$		95	130	μA
				150		
		$V_{EN}\geq 2.0V$, $I_{OUT}=100\mu A$		98	140	
				160		
		$V_{EN}\geq 2.0V$, $I_{OUT}=50mA$		350	600	
		800				
		$V_{EN}\geq 2.0V$, $I_{OUT}=100mA$		600	1000	
				1500		
		$V_{EN}\geq 2.0V$, $I_{OUT}=150mA$		1300	1900	
				2500		
Ripple Rejection	PSRR	frequency=100Hz, $I_{OUT}=100\mu A$		75		dB
Current Limit	I_{LIMIT}	$V_{OUT}=0V$		320	550	mA
Output Noise	e_{no}	$I_{OUT}=50mA$, $C_{OUT}=2.2\mu F$, 100pF from BYP to GND		260		nV/\sqrt{Hz}
Enable Input Logic-Low Voltage	V_{IL}	Regulator shutdown			0.4	V
					0.18	

**150mA RF ULDO REGULATOR****AP2202****Electrical Characteristics (Continued)****AP2202-2.8 Electrical Characteristics**

$V_{IN}=3.8V$, $I_{OUT}=100\mu A$, $C_{IN}=1.0\mu F$, $C_{OUT}=2.2\mu F$, $V_{EN}\geq 2.0V$, $T_J=25^\circ C$, **Bold** typeface applies over $-40^\circ C\leq T_J\leq 125^\circ C$ (note 2), unless otherwise specified.

Parameter	Symbol	Conditions	Min	Typ	Max	Unit
Enable Input Logic-High Voltage	V_{IH}	Regulator enabled	2.0			V
Enable Input Logic-Low Current	I_{IL}	$V_{IL}\leq 0.4V$		0.01	1	μA
		$V_{IL}\leq 0.18V$			2	
Enable Input Logic-High Current	I_{IH}	$V_{IH}\geq 2.0V$		5	20	μA
		$V_{IH}\geq 2.0V$			25	

Note 2: Specifications in bold type are limited to $-40^\circ C\leq T_J\leq 125^\circ C$. Limits over temperature are guaranteed by design, but not tested in production.

Note 3: Output voltage temperature coefficient is defined as the worst case voltage change divided by the total temperature range.

Note 4: Regulation is measured at constant junction temperature using low duty cycle pulse testing. Parts are tested for load regulation in the load range from 0.1mA to 150mA. Changes in output voltage due to heating effects are covered by the thermal regulation specification.

Note 5: Dropout voltage is defined as the input to output differential at which the output voltage drops 1% ($T_J=25^\circ C$) or 2% ($-40^\circ C\leq T_J\leq 125^\circ C$) below its nominal value measured at 1V differential.

Note 6: Ground pin current is the regulator quiescent current plus pass transistor base current. The total current drawn from the supply is the sum of the load current plus the ground pin current.



150mA RF ULDO REGULATOR

AP2202

Electrical Characteristics (Continued)

AP2202-2.9 Electrical Characteristics

$V_{IN}=3.9V$, $I_{OUT}=100\mu A$, $C_{IN}=1.0\mu F$, $C_{OUT}=2.2\mu F$, $V_{EN}\geq 2.0V$, $T_J=25^\circ C$, **Bold** typeface applies over $-40^\circ C \leq T_J \leq 125^\circ C$ (note 2), unless otherwise specified.

Parameter	Symbol	Conditions	Min	Typ	Max	Unit
Output Voltage Accuracy	$\Delta V_{OUT}/V_{OUT}$	Variation from specified V_{OUT}	-1		1	%
			-2		2	
Output Voltage Temperature Coefficient (Note 3)	$\Delta V_{OUT}/\Delta T$			120		$\mu V/^\circ C$
	$(\Delta V_{OUT}/V_{OUT})/\Delta T$			41.3		ppm/ $^\circ C$
Line Regulation	V_{RLINE}	$V_{IN}=3.9V$ to $13.2V$		1	4	mV
					14	
Load Regulation (Note 4)	V_{RLOAD}	$I_{OUT}=0.1mA$ to $150mA$		1	7	mV
					15	
Dropout Voltage (Note 5)	V_{DROP}	$I_{OUT}=100\mu A$		15	50	mV
		$I_{OUT}=50mA$		110	150	
					230	
		$I_{OUT}=100mA$		140	250	
			300			
$I_{OUT}=150mA$		165	275			
			350			
Standby Current	I_{STD}	$V_{EN}\leq 0.4V$ (shutdown)		0.01	1	μA
		$V_{EN}\leq 0.18V$ (shutdown)			5	
Ground Pin Current (Note 6)	I_{GND}	$V_{EN}\geq 2.0V$, $I_{OUT}=0\mu A$		95	130	μA
		$V_{EN}\geq 2.0V$, $I_{OUT}=100\mu A$		98	140	
					160	
		$V_{EN}\geq 2.0V$, $I_{OUT}=50mA$		350	600	
					800	
$V_{EN}\geq 2.0V$, $I_{OUT}=100mA$		600	1000			
			1500			
$V_{EN}\geq 2.0V$, $I_{OUT}=150mA$		1300	1900			
			2500			
Ripple Rejection	PSRR	frequency=100Hz, $I_{OUT}=100\mu A$		75		dB
Current Limit	I_{LIMIT}	$V_{OUT}=0V$		320	550	mA
Output Noise	e_{no}	$I_{OUT}=50mA$, $C_{OUT}=2.2\mu F$, 100pF from BYP to GND		260		nV/\sqrt{Hz}
Enable Input Logic-Low Voltage	V_{IL}	Regulator shutdown			0.4	V
					0.18	

**150mA RF ULDO REGULATOR****AP2202****Electrical Characteristics (Continued)****AP2202-2.9 Electrical Characteristics**

$V_{IN}=3.9V$, $I_{OUT}=100\mu A$, $C_{IN}=1.0\mu F$, $C_{OUT}=2.2\mu F$, $V_{EN}\geq 2.0V$, $T_J=25^\circ C$, **Bold** typeface applies over $-40^\circ C\leq T_J\leq 125^\circ C$ (note 2), unless otherwise specified.

Parameter	Symbol	Conditions	Min	Typ	Max	Unit
Enable Input Logic-High Voltage	V_{IH}	Regulator enabled	2.0			V
Enable Input Logic-Low Current	I_{IL}	$V_{IL}\leq 0.4V$		0.01	1	μA
		$V_{IL}\leq 0.18V$			2	
Enable Input Logic-High Current	I_{IH}	$V_{IH}\geq 2.0V$		5	20	μA
		$V_{IH}\geq 2.0V$			25	

Note 2: Specifications in bold type are limited to $-40^\circ C\leq T_J\leq 125^\circ C$. Limits over temperature are guaranteed by design, but not tested in production.

Note 3: Output voltage temperature coefficient is defined as the worst case voltage change divided by the total temperature range.

Note 4: Regulation is measured at constant junction temperature using low duty cycle pulse testing. Parts are tested for load regulation in the load range from 0.1mA to 150mA. Changes in output voltage due to heating effects are covered by the thermal regulation specification.

Note 5: Dropout voltage is defined as the input to output differential at which the output voltage drops 1% ($T_J=25^\circ C$) or 2% ($-40^\circ C\leq T_J\leq 125^\circ C$) below its nominal value measured at 1V differential.

Note 6: Ground pin current is the regulator quiescent current plus pass transistor base current. The total current drawn from the supply is the sum of the load current plus the ground pin current.



150mA RF ULDO REGULATOR

AP2202

Electrical Characteristics (Continued)

AP2202-3.0 Electrical Characteristics

$V_{IN}=4V$, $I_{OUT}=100\mu A$, $C_{IN}=1.0\mu F$, $C_{OUT}=2.2\mu F$, $V_{EN}\geq 2.0V$, $T_J=25^\circ C$, **Bold** typeface applies over $-40^\circ C\leq T_J\leq 125^\circ C$ (note 2), unless otherwise specified.

Parameter	Symbol	Conditions	Min	Typ	Max	Unit
Output Voltage Accuracy	$\Delta V_{OUT}/V_{OUT}$	Variation from specified V_{OUT}	-1		1	%
			-2		2	
Output Voltage Temperature Coefficient (Note 3)	$\Delta V_{OUT}/\Delta T$			120		$\mu V/^\circ C$
	$(\Delta V_{OUT}/V_{OUT})/\Delta T$			40		ppm/ $^\circ C$
Line Regulation	V_{RLINE}	$V_{IN}=4V$ to 13.2V		1	4	mV
					14	
Load Regulation (Note 4)	V_{RLOAD}	$I_{OUT}=0.1mA$ to 150mA		1	7	mV
					15	
Dropout Voltage (Note 5)	V_{DROP}	$I_{OUT}=100\mu A$		15	50	mV
					70	
		$I_{OUT}=50mA$		110	150	
					230	
		$I_{OUT}=100mA$		140	250	
					300	
		$I_{OUT}=150mA$		165	275	
					350	
Standby Current	I_{STD}	$V_{EN}\leq 0.4V$ (shutdown)		0.01	1	μA
		$V_{EN}\leq 0.18V$ (shutdown)			5	
Ground Pin Current (Note 6)	I_{GND}	$V_{EN}\geq 2.0V$, $I_{OUT}=0\mu A$		95	130	μA
					150	
		$V_{EN}\geq 2.0V$, $I_{OUT}=100\mu A$		98	140	
					160	
		$V_{EN}\geq 2.0V$, $I_{OUT}=50mA$		350	600	
			800			
		$V_{EN}\geq 2.0V$, $I_{OUT}=100mA$		600	1000	
					1500	
		$V_{EN}\geq 2.0V$, $I_{OUT}=150mA$		1300	1900	
					2500	
Ripple Rejection	PSRR	frequency=100Hz, $I_{OUT}=100\mu A$		75		dB
Current Limit	I_{LIMIT}	$V_{OUT}=0V$		320	550	mA
Output Noise	e_{no}	$I_{OUT}=50mA$, $C_{OUT}=2.2\mu F$, 100pF from BYP to GND		260		nV/\sqrt{Hz}
Enable Input Logic-Low Voltage	V_{IL}	Regulator shutdown			0.4	V
					0.18	

**150mA RF ULDO REGULATOR****AP2202****Electrical Characteristics (Continued)****AP2202-3.0 Electrical Characteristics**

$V_{IN}=4V$, $I_{OUT}=100\mu A$, $C_{IN}=1.0\mu F$, $C_{OUT}=2.2\mu F$, $V_{EN}\geq 2.0V$, $T_J=25^\circ C$, **Bold** typeface applies over $-40^\circ C\leq T_J\leq 125^\circ C$ (note 2), unless otherwise specified.

Parameter	Symbol	Conditions	Min	Typ	Max	Unit
Enable Input Logic-High Voltage	V_{IH}	Regulator enabled	2.0			V
Enable Input Logic-Low Current	I_{IL}	$V_{IL}\leq 0.4V$		0.01	1	μA
		$V_{IL}\leq 0.18V$			2	
Enable Input Logic-High Current	I_{IH}	$V_{IH}\geq 2.0V$		5	20	μA
		$V_{IH}\geq 2.0V$			25	

Note 2: Specifications in bold type are limited to $-40^\circ C\leq T_J\leq 125^\circ C$. Limits over temperature are guaranteed by design, but not tested in production.

Note 3: Output voltage temperature coefficient is defined as the worst case voltage change divided by the total temperature range.

Note 4: Regulation is measured at constant junction temperature using low duty cycle pulse testing. Parts are tested for load regulation in the load range from 0.1mA to 150mA. Changes in output voltage due to heating effects are covered by the thermal regulation specification.

Note 5: Dropout voltage is defined as the input to output differential at which the output voltage drops 1% ($T_J=25^\circ C$) or 2% ($-40^\circ C\leq T_J\leq 125^\circ C$) below its nominal value measured at 1V differential.

Note 6: Ground pin current is the regulator quiescent current plus pass transistor base current. The total current drawn from the supply is the sum of the load current plus the ground pin current.



150mA RF ULDO REGULATOR

AP2202

Electrical Characteristics (Continued)

AP2202-3.3 Electrical Characteristics

$V_{IN}=4.3V$, $I_{OUT}=100\mu A$, $C_{IN}=1.0\mu F$, $C_{OUT}=2.2\mu F$, $V_{EN}\geq 2.0V$, $T_J=25^\circ C$, **Bold** typeface applies over $-40^\circ C \leq T_J \leq 125^\circ C$ (note 2), unless otherwise specified.

Parameter	Symbol	Conditions	Min	Typ	Max	Unit
Output Voltage Accuracy	$\Delta V_{OUT}/V_{OUT}$	Variation from specified V_{OUT}	-1		1	%
			-2		2	
Output Voltage Temperature Coefficient (Note 3)	$\Delta V_{OUT}/\Delta T$			120		$\mu V/^\circ C$
	$(\Delta V_{OUT}/V_{OUT})/\Delta T$			36.3		ppm/ $^\circ C$
Line Regulation	V_{RLINE}	$V_{IN}=4.3V$ to $13.2V$		1	5	mV
					15	
Load Regulation (Note 4)	V_{RLOAD}	$I_{OUT}=0.1mA$ to $150mA$		1	8	mV
					17	
Dropout Voltage (Note 5)	V_{DROP}	$I_{OUT}=100\mu A$		15	50	mV
				70		
		$I_{OUT}=50mA$		110	150	
				230		
		$I_{OUT}=100mA$		140	250	
					300	
		$I_{OUT}=150mA$		165	275	
					350	
Standby Current	I_{STD}	$V_{EN}\leq 0.4V$ (shutdown)		0.01	1	μA
		$V_{EN}\leq 0.18V$ (shutdown)			5	
Ground Pin Current (Note 6)	I_{GND}	$V_{EN}\geq 2.0V$, $I_{OUT}=0\mu A$		95	130	μA
					150	
		$V_{EN}\geq 2.0V$, $I_{OUT}=100\mu A$		98	140	
					160	
		$V_{EN}\geq 2.0V$, $I_{OUT}=50mA$		350	600	
			800			
		$V_{EN}\geq 2.0V$, $I_{OUT}=100mA$		600	1000	
					1500	
		$V_{EN}\geq 2.0V$, $I_{OUT}=150mA$		1300	1900	
					2500	
Ripple Rejection	PSRR	frequency=100Hz, $I_{OUT}=100\mu A$		75		dB
Current Limit	I_{LIMIT}	$V_{OUT}=0V$		320	550	mA
Output Noise	e_{no}	$I_{OUT}=50mA$, $C_{OUT}=2.2\mu F$, 100pF from BYP to GND		260		nV/\sqrt{Hz}
Enable Input Logic-Low Voltage	V_{IL}	Regulator shutdown			0.4	V
					0.18	

**150mA RF ULDO REGULATOR****AP2202****Electrical Characteristics (Continued)****AP2202-3.3 Electrical Characteristics**

$V_{IN}=4.3V$, $I_{OUT}=100\mu A$, $C_{IN}=1.0\mu F$, $C_{OUT}=2.2\mu F$, $V_{EN}\geq 2.0V$, $T_J=25^\circ C$, **Bold** typeface applies over $-40^\circ C\leq T_J\leq 125^\circ C$ (note 2), unless otherwise specified.

Parameter	Symbol	Conditions	Min	Typ	Max	Unit
Enable Input Logic-High Voltage	V_{IH}	Regulator enabled	2.0			V
Enable Input Logic-Low Current	I_{IL}	$V_{IL}\leq 0.4V$		0.01	1	μA
		$V_{IL}\leq 0.18V$			2	
Enable Input Logic-High Current	I_{IH}	$V_{IH}\geq 2.0V$		5	20	μA
		$V_{IH}\geq 2.0V$			25	

Note 2: Specifications in bold type are limited to $-40^\circ C\leq T_J\leq 125^\circ C$. Limits over temperature are guaranteed by design, but not tested in production.

Note 3: Output voltage temperature coefficient is defined as the worst case voltage change divided by the total temperature range.

Note 4: Regulation is measured at constant junction temperature using low duty cycle pulse testing. Parts are tested for load regulation in the load range from 0.1mA to 150mA. Changes in output voltage due to heating effects are covered by the thermal regulation specification.

Note 5: Dropout voltage is defined as the input to output differential at which the output voltage drops 1% ($T_J=25^\circ C$) or 2% ($-40^\circ C\leq T_J\leq 125^\circ C$) below its nominal value measured at 1V differential.

Note 6: Ground pin current is the regulator quiescent current plus pass transistor base current. The total current drawn from the supply is the sum of the load current plus the ground pin current.



150mA RF ULDO REGULATOR

AP2202

Electrical Characteristics (Continued)

AP2202-4.0 Electrical Characteristics

$V_{IN}=5V$, $I_{OUT}=100\mu A$, $C_{IN}=1.0\mu F$, $C_{OUT}=2.2\mu F$, $V_{EN}\geq 2.0V$, $T_J=25^\circ C$, **Bold** typeface applies over $-40^\circ C \leq T_J \leq 125^\circ C$ (note 2), unless otherwise specified.

Parameter	Symbol	Conditions	Min	Typ	Max	Unit
Output Voltage Accuracy	$\Delta V_{OUT}/V_{OUT}$	Variation from specified V_{OUT}	-1		1	%
			-2		2	
Output Voltage Temperature Coefficient (Note 3)	$\Delta V_{OUT}/\Delta T$			120		$\mu V/^\circ C$
	$(\Delta V_{OUT}/V_{OUT})/\Delta T$			30		ppm/ $^\circ C$
Line Regulation	V_{RLINE}	$V_{IN}=5V$ to 13.2V		1	6	mV
					17	
Load Regulation (Note 4)	V_{RLOAD}	$I_{OUT}=0.1mA$ to 150mA		1	9	mV
					20	
Dropout Voltage (Note 5)	V_{DROP}	$I_{OUT}=100\mu A$		15	50	mV
				70		
		$I_{OUT}=50mA$		110	150	
				230		
		$I_{OUT}=100mA$		140	250	
					300	
		$I_{OUT}=150mA$		165	275	
					350	
Standby Current	I_{STD}	$V_{EN}\leq 0.4V$ (shutdown)		0.01	1	μA
		$V_{EN}\leq 0.18V$ (shutdown)			5	
Ground Pin Current (Note 6)	I_{GND}	$V_{EN}\geq 2.0V$, $I_{OUT}=0\mu A$		95	130	μA
					150	
		$V_{EN}\geq 2.0V$, $I_{OUT}=100\mu A$		98	140	
					160	
		$V_{EN}\geq 2.0V$, $I_{OUT}=50mA$		350	600	
			800			
		$V_{EN}\geq 2.0V$, $I_{OUT}=100mA$		600	1000	
					1500	
		$V_{EN}\geq 2.0V$, $I_{OUT}=150mA$		1300	1900	
					2500	
Ripple Rejection	PSRR	frequency=100Hz, $I_{OUT}=100\mu A$		75		dB
Current Limit	I_{LIMIT}	$V_{OUT}=0V$		320	550	mA
Output Noise	e_{no}	$I_{OUT}=50mA$, $C_{OUT}=2.2\mu F$, 100pF from BYP to GND		260		nV/\sqrt{Hz}
Enable Input Logic-Low Voltage	V_{IL}	Regulator shutdown			0.4	V
					0.18	

**150mA RF ULDO REGULATOR****AP2202****Electrical Characteristics (Continued)****AP2202-4.0 Electrical Characteristics**

$V_{IN}=5V$, $I_{OUT}=100\mu A$, $C_{IN}=1.0\mu F$, $C_{OUT}=2.2\mu F$, $V_{EN}\geq 2.0V$, $T_J=25^\circ C$, **Bold** typeface applies over $-40^\circ C\leq T_J\leq 125^\circ C$ (note 2), unless otherwise specified.

Parameter	Symbol	Conditions	Min	Typ	Max	Unit
Enable Input Logic-High Voltage	V_{IH}	Regulator enabled	2.0			V
Enable Input Logic-Low Current	I_{IL}	$V_{IL}\leq 0.4V$		0.01	1	μA
		$V_{IL}\leq 0.18V$			2	
Enable Input Logic-High Current	I_{IH}	$V_{IH}\geq 2.0V$		5	20	μA
		$V_{IH}\geq 2.0V$			25	

Note 2: Specifications in bold type are limited to $-40^\circ C\leq T_J\leq 125^\circ C$. Limits over temperature are guaranteed by design, but not tested in production.

Note 3: Output voltage temperature coefficient is defined as the worst case voltage change divided by the total temperature range.

Note 4: Regulation is measured at constant junction temperature using low duty cycle pulse testing. Parts are tested for load regulation in the load range from 0.1mA to 150mA. Changes in output voltage due to heating effects are covered by the thermal regulation specification.

Note 5: Dropout voltage is defined as the input to output differential at which the output voltage drops 1% ($T_J=25^\circ C$) or 2% ($-40^\circ C\leq T_J\leq 125^\circ C$) below its nominal value measured at 1V differential.

Note 6: Ground pin current is the regulator quiescent current plus pass transistor base current. The total current drawn from the supply is the sum of the load current plus the ground pin current.



150mA RF ULDO REGULATOR

AP2202

Typical Performance Characteristics

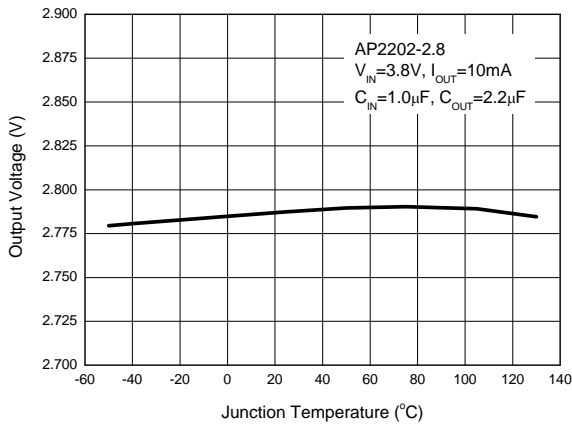

Figure 4. Output Voltage vs. Junction Temperature

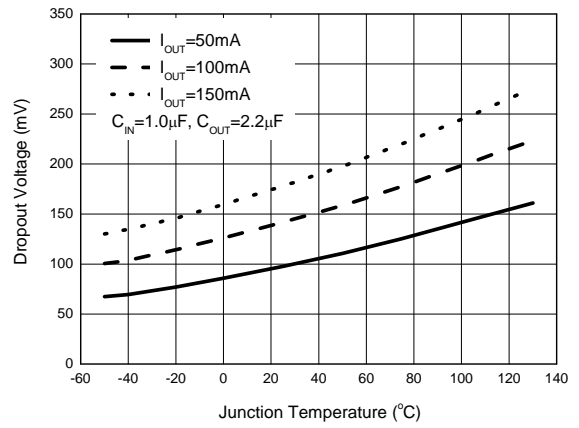

Figure 5. Dropout Voltage vs. Junction Temperature

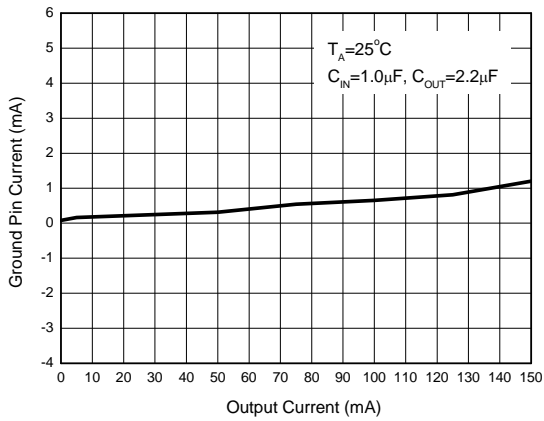

Figure 6. Ground Pin Current vs. Output Current

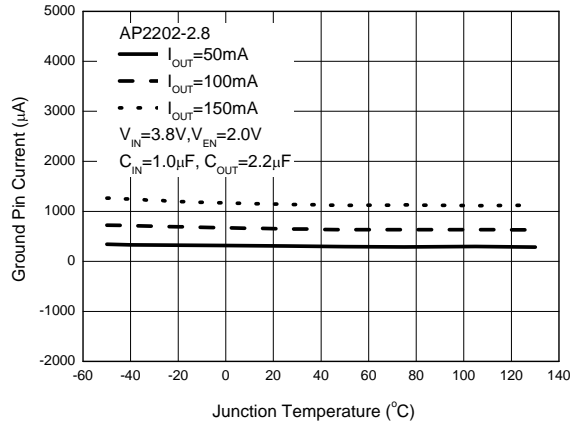

Figure 7. Ground Pin Current vs. Junction Temperature



150mA RF ULDO REGULATOR

AP2202

Typical Performance Characteristics (Continued)

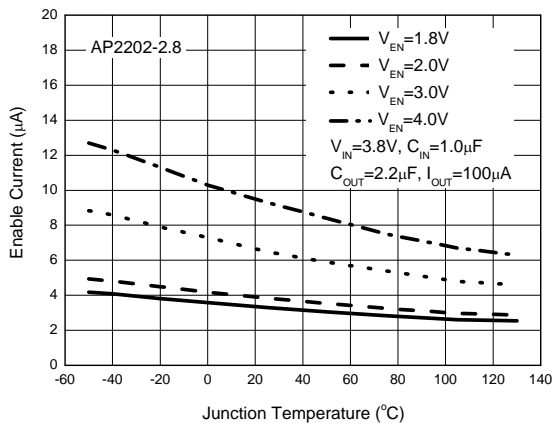

Figure 8. Enable Current vs. Junction Temperature

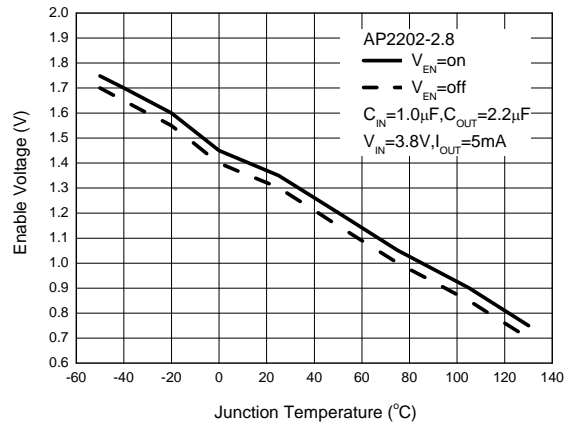

Figure 9. Enable Voltage vs. Junction Temperature

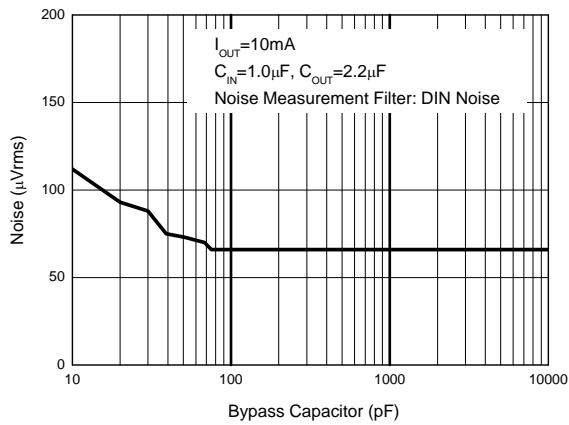

Figure 10. Noise vs. Bypass Capacitor

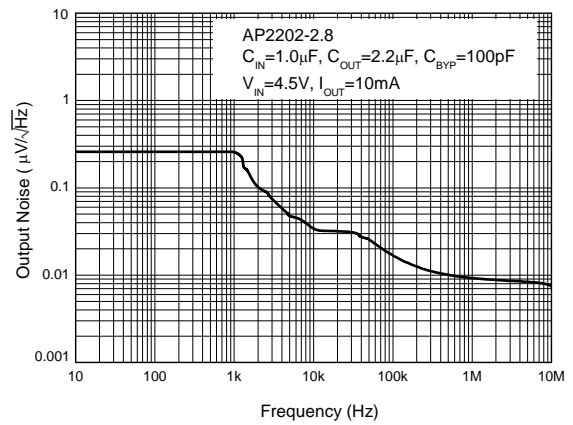

Figure 11. Output Noise vs. Frequency



150mA RF ULDO REGULATOR

AP2202

Typical Performance Characteristics (Continued)

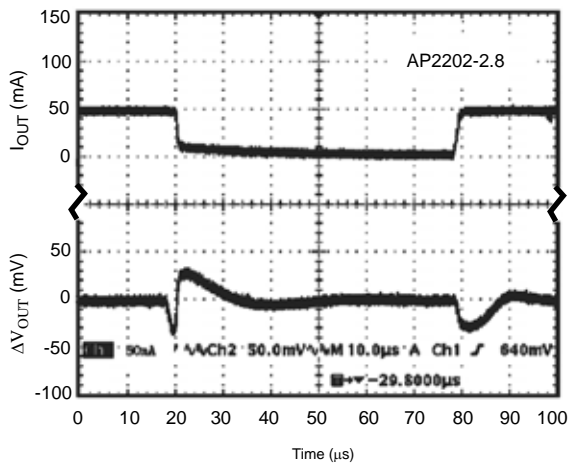

Figure 12. Load Transient
(Conditions: $V_{IN}=3.8V$, $C_{BYP}=100pF$, $V_{EN}=2V$, $I_{OUT}=5mA$ to $50mA$, $C_{IN}=1.0\mu F$, $C_{OUT}=2.2\mu F$)

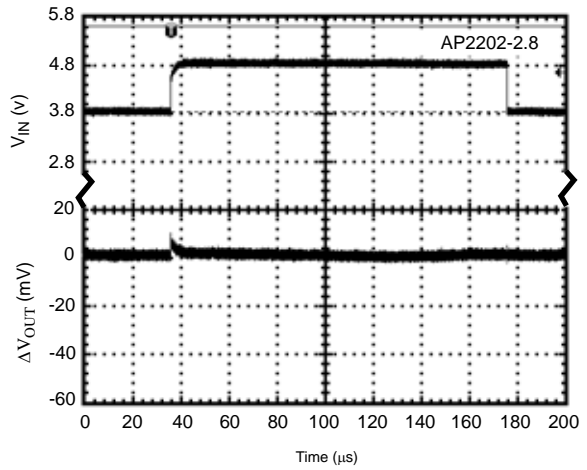

Figure 13. Line Transient
(Conditions: $V_{IN}=3.8V$ to $4.8V$, $V_{EN}=2V$, $I_{OUT}=100\mu A$, $C_{BYP}=100pF$, $C_{OUT}=10\mu F$)

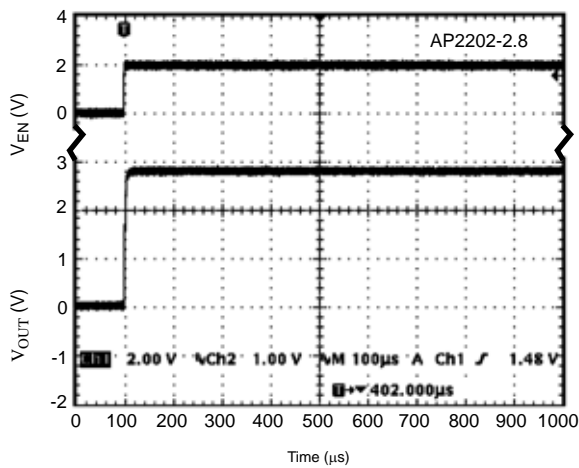

Figure 14. $V_{EN}(on)$ vs. V_{OUT}
(Conditions: $V_{EN}=0V$ to $2V$, $V_{IN}=3.8V$, $I_{OUT}=30mA$, $C_{BYP}=open$, $C_{IN}=1.0\mu F$, $C_{OUT}=2.2\mu F$)

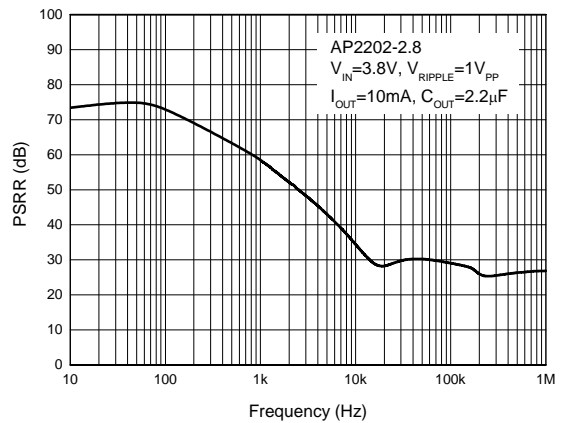

Figure 15. PSRR vs. Frequency



150mA RF ULDO REGULATOR

AP2202

Typical Performance Characteristics (Continued)

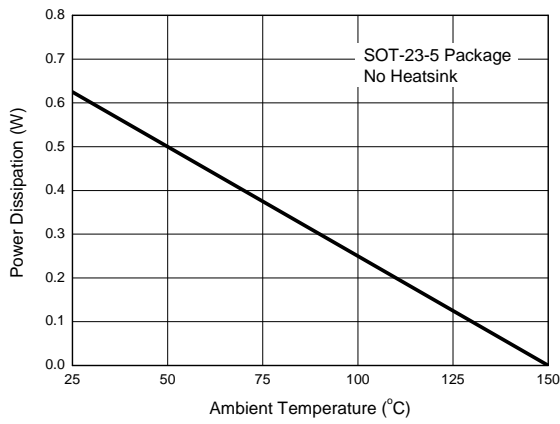

Figure 16. Power Dissipation vs. Ambient Temperature

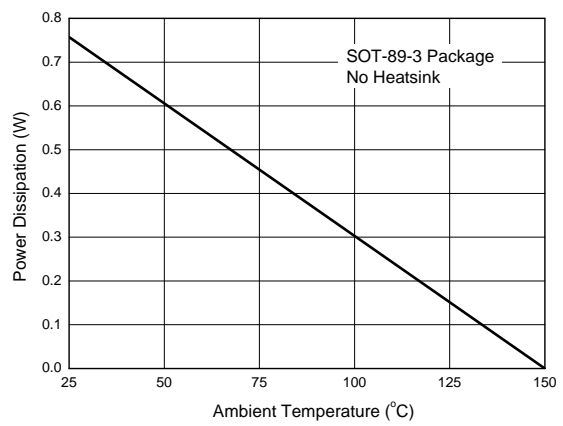

Figure 17. Power Dissipation vs. Ambient Temperature

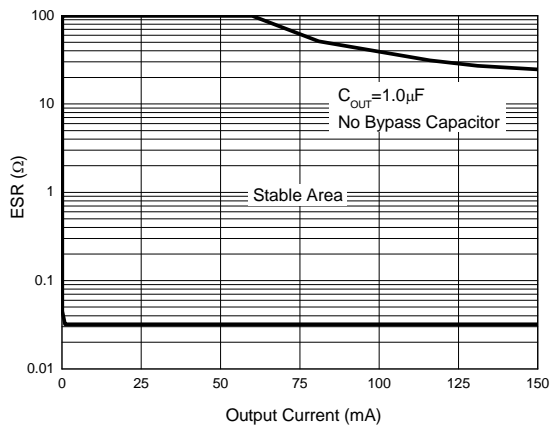

Figure 18. ESR vs. Output Current

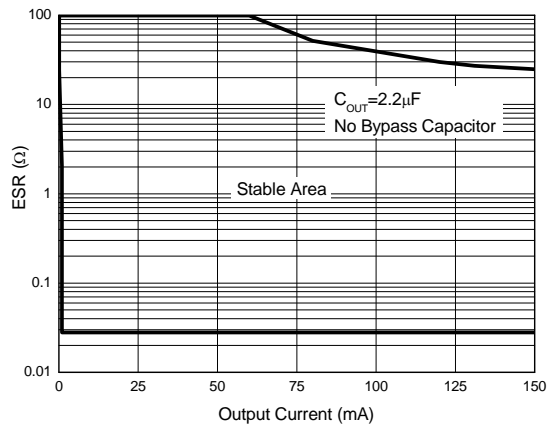

Figure 19. ESR vs. Output Current



150mA RF ULDO REGULATOR

AP2202

Typical Performance Characteristics (Continued)

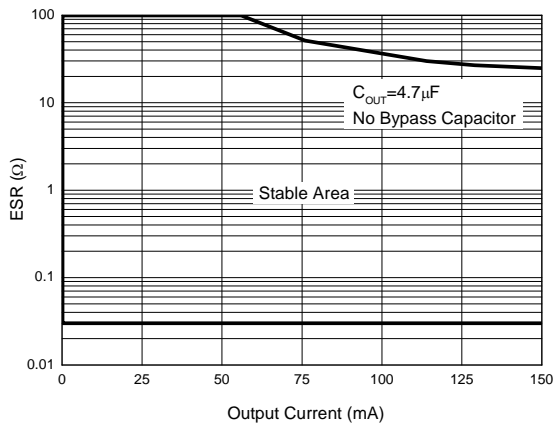

Figure 20. ESR vs. Output Current



150mA RF ULDO REGULATOR

AP2202

Typical Application

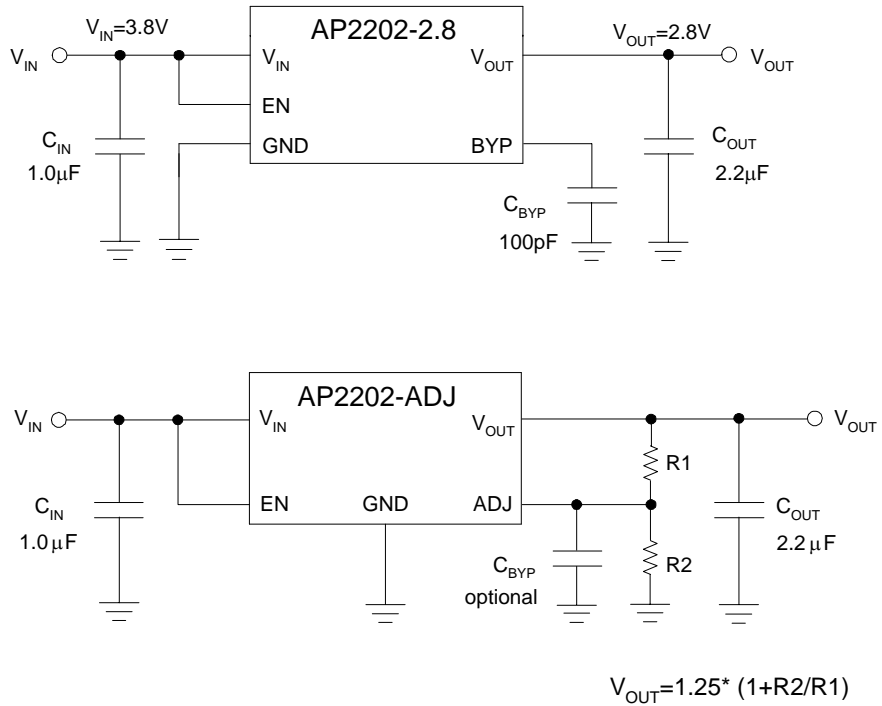

Figure 21. Typical Application of AP2202 (Note 7)

Note 7: Dropout voltage is 165mV when $T_A=25^{\circ}C$. In order to obtain a normal output voltage, $V_{OUT}+0.165V$ is the minimum input voltage which will result in a low PSRR, imposing a bad influence on system. Therefore, the recommended input voltage is $V_{OUT}+0.5V$ to 13.2V. For AP2202-2.8 version, its input voltage can be set from 3.3V($V_{OUT}+0.5V$) to 13.2V. For that of Adj version, any value from $V_{OUT}+0.5V$ to 13.2V is available. R1 and R2 must be correctly selected when setting the output voltage. For example, if 3.0V output voltage is required, R1 and R2 can be set to 10kΩ and 14kΩ respectively. For Adj version, we recommend 2.3V as minimum output voltage.

**150mA RF ULDO REGULATOR****AP2202****Application Information****Input Capacitor**

A 1 μ F minimum capacitor is recommended to be placed between V_{IN} and GND.

Output Capacitor

It is required to prevent oscillation. 1.0 μ F minimum is recommended when C_{BYP} is unused. 2.2 μ F minimum is recommended when C_{BYP} is 100pF. The output capacitor may be increased to improve transient response.

Noise Bypass Capacitor

Bypass capacitor is connected to the internal voltage reference. A 100pF capacitor connected from BYP to GND make this reference quiet, resulting in a significant reduction in output noise, but the ESR stable area will be narrowed.

The start-up speed of the AP2202 is inversely proportional to the value of reference bypass capacitor. In some cases, if output noise is not a major concern and rapid turn-on is necessary, omit C_{BYP} and leave BYP open.

Power Dissipation

Thermal shutdown may take place if exceeding the maximum power dissipation in application. Under all possible operating conditions, the junction temperature must be within the range specified under absolute maximum ratings to avoid thermal shutdown.

To determine if the power dissipated in the regulator reaches the maximum power dissipation (see figure 16,17), using:

$$T_J = P_D * \theta_{JA} + T_A$$

$$P_D = (V_{IN} - V_{OUT}) * I_{OUT} + V_{IN} * I_{GND}$$

Where: $T_J \leq T_{J(max)}$, $T_{J(max)}$ is absolute maximum ratings for the junction temperature; $V_{IN} * I_{GND}$ can be ignored due to its small value.

$T_{J(max)}$ is 150°C, θ_{JA} is 200°C/W for SOT-23-5 package and 165°C/W for SOT-89-3 package, no heatsink is required since the package alone will dissipate enough heat to satisfy these requirements unless the calculated value for power dissipation exceeds the limit.

Example: For 2.8V version packaged in SOT-23-5,

$I_{OUT} = 150mA$, $T_A = 50^\circ C$, $V_{IN(Max)}$ is:

$$(150^\circ C - 50^\circ C) / (0.15A * 200^\circ C/W) + 2.8V = 6.133V$$

Therefore, for good performance, please make sure that input voltage is less than 6.133V without heat-sink when $T_A = 50^\circ C$.



150mA RF ULDO REGULATOR

AP2202

Mechanical Dimensions

SOT-23-5

Unit: mm(inch)

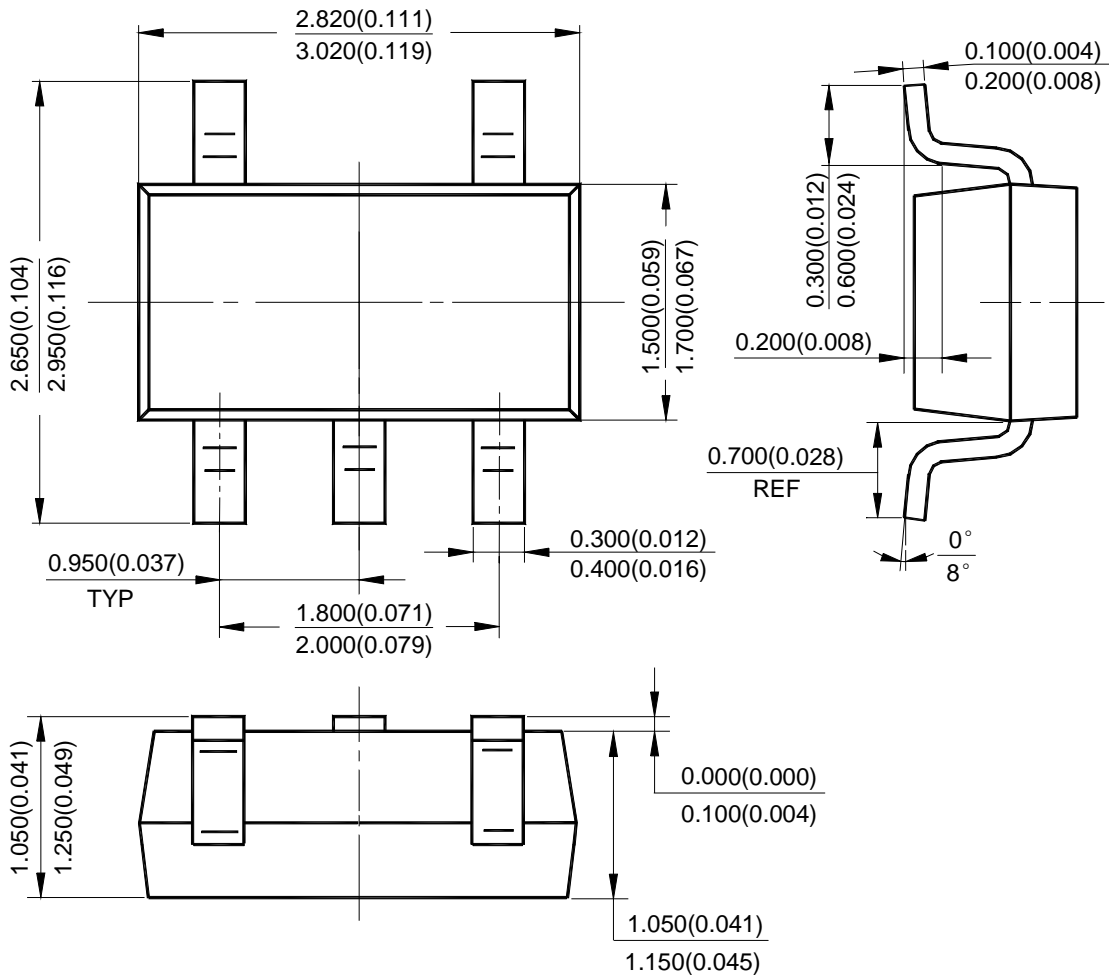



150mA RF ULDO REGULATOR

AP2202

Mechanical Dimensions (Continued)

SOT-89-3

Unit: mm(inch)

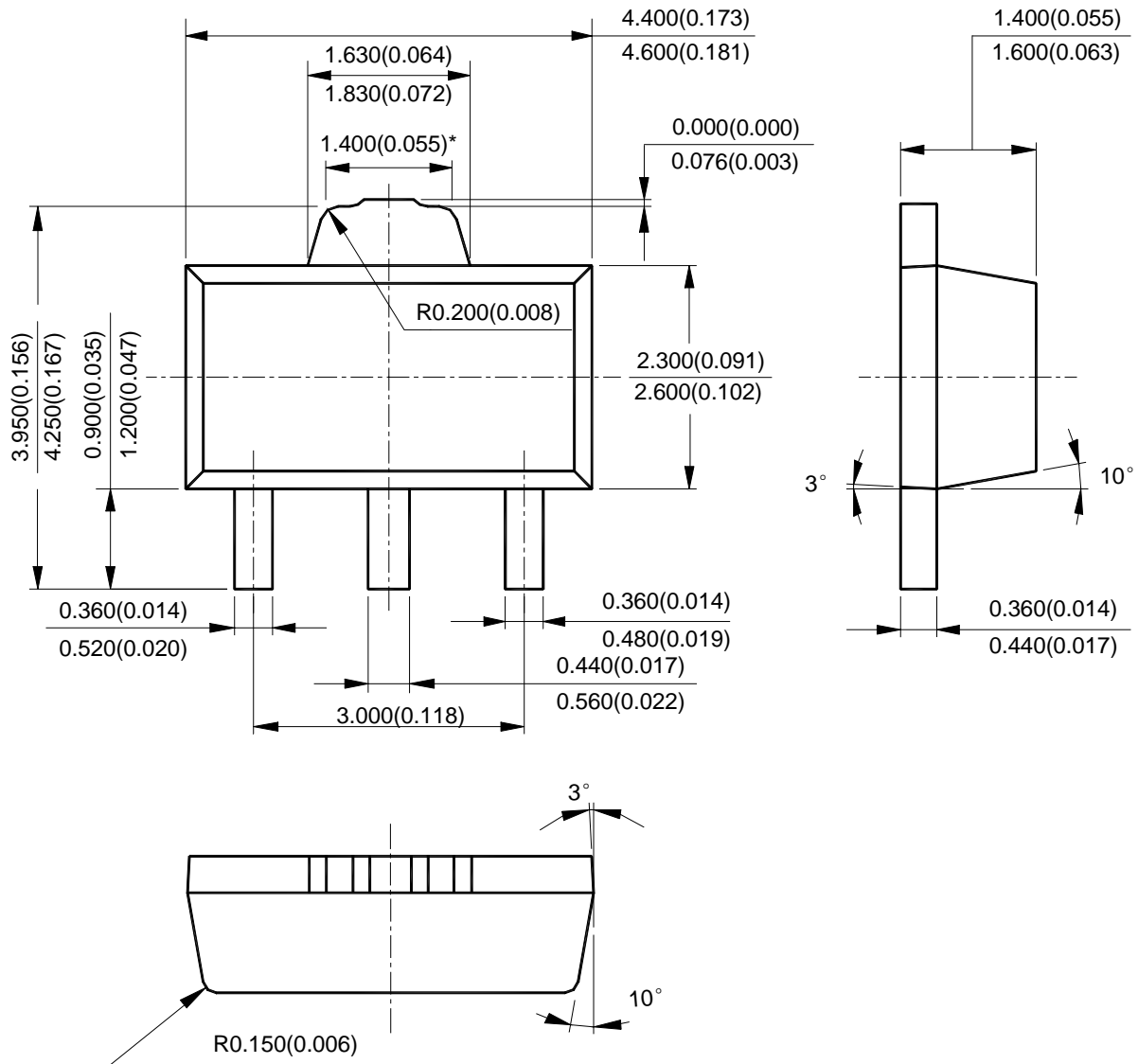



BCD Semiconductor Manufacturing Limited

<http://www.bcdsemi.com>

IMPORTANT NOTICE

BCD Semiconductor Manufacturing Limited reserves the right to make changes without further notice to any products or specifications herein. BCD Semiconductor Manufacturing Limited does not assume any responsibility for use of any its products for any particular purpose, nor does BCD Semiconductor Manufacturing Limited assume any liability arising out of the application or use of any its products or circuits. BCD Semiconductor Manufacturing Limited does not convey any license under its patent rights or other rights nor the rights of others.

MAIN SITE

BCD Semiconductor Manufacturing Limited
- Wafer Fab
Shanghai SIM-BCD Semiconductor Manufacturing Limited
800, Yi Shan Road, Shanghai 200233, China
Tel: +86-21-6485 1491, Fax: +86-21-5450 0008

BCD Semiconductor Manufacturing Limited
- IC Design Group
Advanced Analog Circuits (Shanghai) Corporation
8F, Zone B, 900, Yi Shan Road, Shanghai 200233, China
Tel: +86-21-6495 9539, Fax: +86-21-6485 9673

REGIONAL SALES OFFICE

Shenzhen Office
Shanghai SIM-BCD Semiconductor Manufacturing Co., Ltd. Shenzhen Office
Advanced Analog Circuits (Shanghai) Corporation Shenzhen Office
Room E, 5F, Noble Center, No.1006, 3rd Fuzhong Road, Futian District, Shenzhen 518026, China
Tel: +86-755-8826 7951
Fax: +86-755-8826 7865

Taiwan Office
BCD Semiconductor (Taiwan) Company Limited
4F, 298-1, Rui Guang Road, Nei-Hu District, Taipei,
Taiwan
Tel: +886-2-2656 2808
Fax: +886-2-2656 2806

USA Office
BCD Semiconductor Corporation
30920 Huntwood Ave. Hayward,
CA 94544, U.S.A
Tel : +1-510-324-2988
Fax: +1-510-324-2788